

Color Video Camera

Operating Instructions

EN

EVI-D30

EVI-D31 *(For European model only)*

Owner's Record

The model number and the serial number are located on the bottom exterior.

Record these numbers in the spaces provided below. Refer to these numbers whenever you call upon the dealer regarding this product.

Model No. _____

Serial No. _____

WARNING

To prevent fire or shock hazard, do not expose the unit to rain or moisture.

WARNING

Mains cord must only be changed at qualified service shop.

Apparatet er forsynet med en speciel netledning, der kun må udskiftes af et autoriseret serviceværksted.

For customers in the U.S.A.

This equipment has been tested and found to comply with the limits for a Class B digital device, pursuant to Part 15 of the FCC Rules. These limits are designed to provide reasonable protection against harmful interference in a residential installation. This equipment generates, uses, and can radiate radio frequency energy and, if not installed and used in accordance with the instructions, may cause harmful interference to radio communications. However, there is no guarantee that interference will not occur in a particular installation. If this equipment does cause harmful interference to radio or television reception, which can be determined by turning the equipment off and on, the user is encouraged to try to correct the interference by one or more of the following measures:

- Reorient or relocate the receiving antenna.
- Increase the separation between the equipment and receiver.
- Connect the equipment into an outlet on a circuit different from that to which the receiver is connected.
- Consult the dealer or an experienced radio/TV technician for help.

You are cautioned that any changes or modifications not expressly approved in this manual could void your authority to operate this equipment.

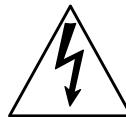
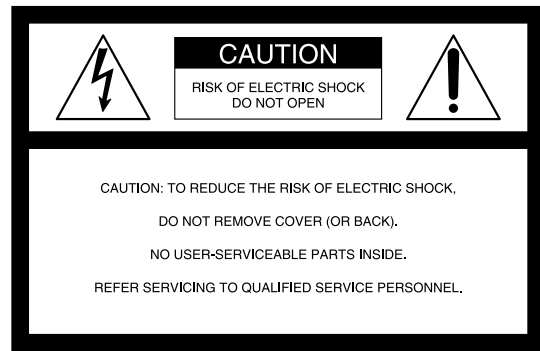

This symbol is intended to alert the user to the presence of uninsulated “dangerous voltage” within the product’s enclosure that may be of sufficient magnitude to constitute a risk of electric shock to persons.



This symbol is intended to alert the user to the presence of important operating and maintenance (servicing) instructions in the literature accompanying the appliance.

* The graphical symbols are on the bottom enclosure.

For the customers in Canada

This Class B digital apparatus meets all requirements of the Canadian Interference-Causing Equipment Regulations.

CAUTION:

TO PREVENT ELECTRIC SHOCK, MATCH WIDE BLADE OF PLUG TO WIDE SLOT, FULLY INSERT.

Pour les utilisateurs au Canada

Cet appareil numérique de la classe B respecte toutes les exigences du Règlement sur le matériel brouilleur du Canada.

ATTENTION:

POUR ÉVITER LES CHOCS ÉLECTRIQUES, INTRODUIRE LA LAME LA PLUS LARGE DE LA FICHE DANS LA BORNE CORRESPONDANTE DE LA PRISE ET POUSSER JUSQU’AU FOND.

For the customers in Netherlands Voor de klanten in Nederland

Bij dit produkt zijn
batterijen geleverd.
Wanneer deze leeg zijn,
moet u ze niet weggooien
maar inleveren als KCA.

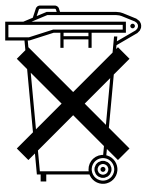

Als de kleuren-videocamera niet meer werkt

Voor u de kleuren-videocamera wegdoet, dient u de
lithiumbatterij eruit te verwijderen om deze in te
leveren als KCA.

- 1 Draai de schroef aan de achterzijde van de
camerakop los met een kruiskop-
schroevendraaier en open de kap.

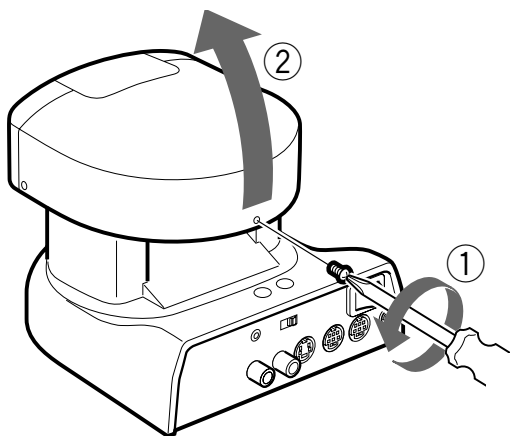

- 2 Maak de klem en de aansluiting los.

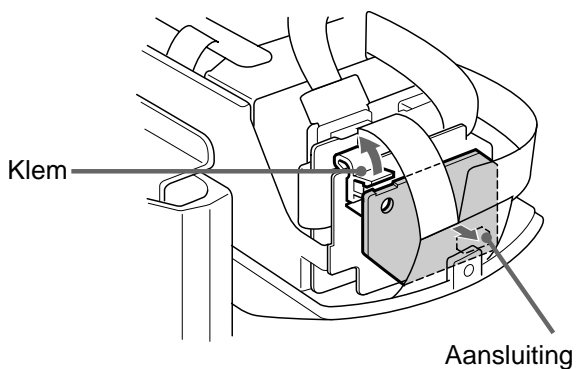

- 3 Verwijder het plaatje met de lithiumbatterij.

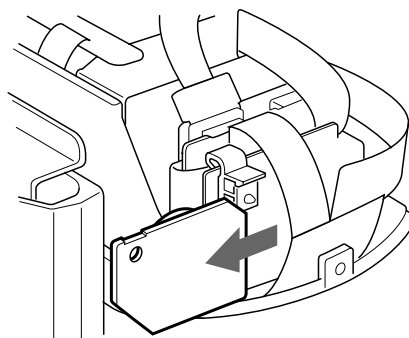

Zorg dat de lithiumbatterij niet in het afval
terecht komt, maar lever deze in als KCA.

EN

Features

- The CCD features effective picture elements of 380,000 (EVI-D30)/440,000 (EVI-D31), which enables you high-resolution shooting.
- In addition to high-speed pan/tilt action, AT (Automatic target tracking) and MD (Motion detector) features are integrated, which lets you use Color Video Camera for a variety of purposes.
- VISCA lets you operate Color Video Camera with a personal computer.
- Up to six combinations of the camera's position and status can be memorized.
- Multi-function remote commander provided.

Table of Contents

Preparations

Connections	6
If you have a personal computer or audio/video equipment with the S-video input	7
Turning on the Power	8
Setting the Clock	8

Basic Operations

Pan/Tilt Operation	10
Adjusting the Camera	11
Having the Camera Memorize the Setting	12

Advanced Operations

Tracking a Subject Automatically	14
Fine-tuning the setting	16
If a subject cannot be recognized or captured	17
Detecting the Change Taking Place in the Picture	18
Fine-tuning the setting	20

General

Locations of Controls	22
Precautions	25
Maintenance	26
Troubleshooting	26
Specifications	27

Connections

Connect your Color Video Camera to a personal computer, TV or VCR equipped with an audio/video input. Some connections may require extra cables. Refer to the instructions manual of the equipment to be connected.

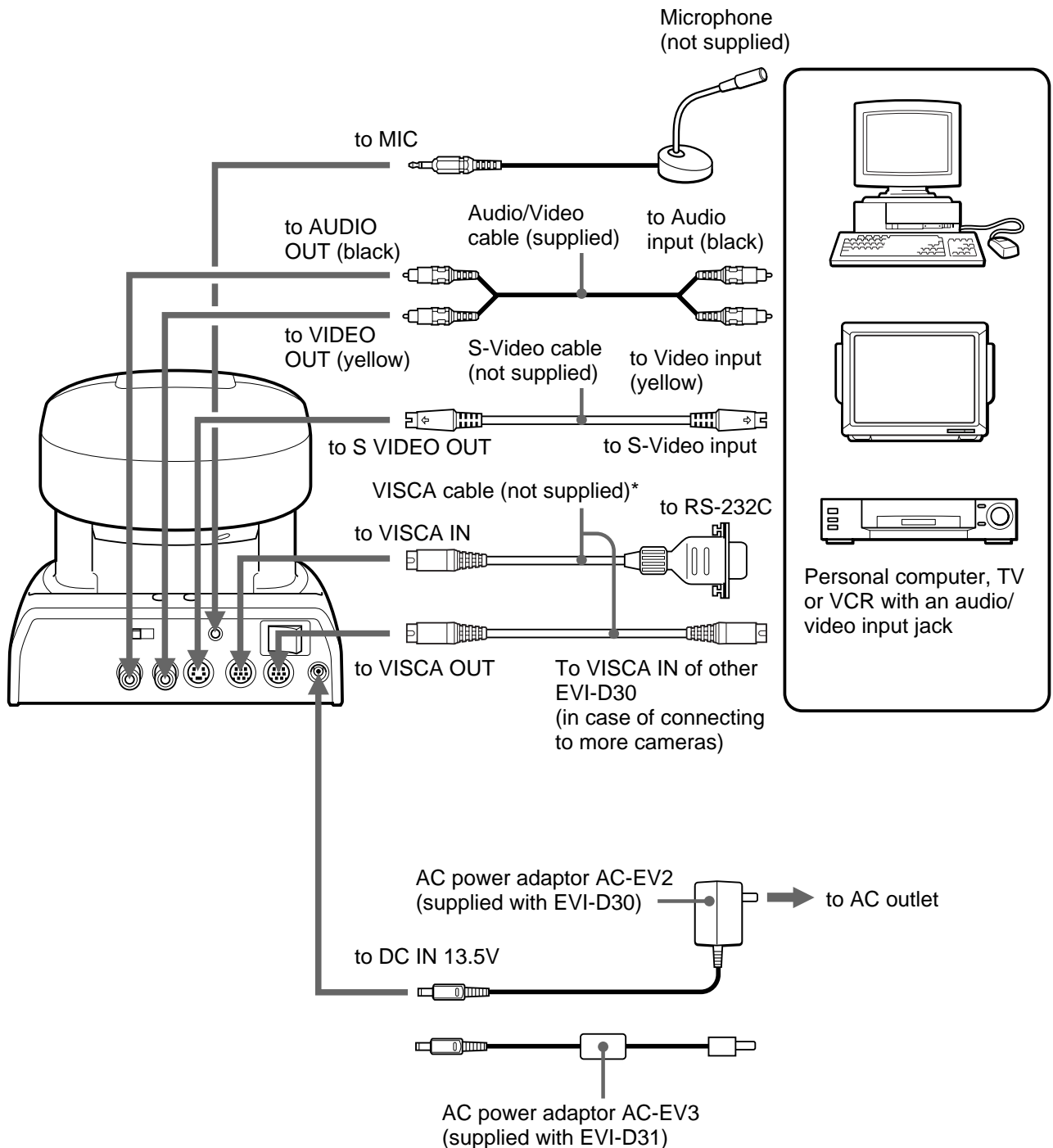

* When the video camera is connected to a personal computer with a VISCA cable, you can operate the video camera with the personal computer.

If you have a personal computer or audio/video equipment with the S-Video input

You can connect it to your Color Video Camera with a commercially available S-video cable.

Notes

- You cannot connect your Color Video Camera to a personal computer that is not equipped with either audio/video input or S-Video input jack. And you might not be able to use your existing personal computer with your Color Video Camera unless you provide the computer with a video capture board, sound board, and/or software. Consult your computer dealer or manufacturer for details.
- Use only the AC-EV2 (for EVI-D30)/AC-EV3 (for EVI-D31) AC power adaptor (supplied). Do not use any other AC power adaptor.

Polarity of the plug



- Do not grasp the camera head when carrying the video camera.
- Do not turn the camera head manually. Doing so will result in the camera malfunctioning.

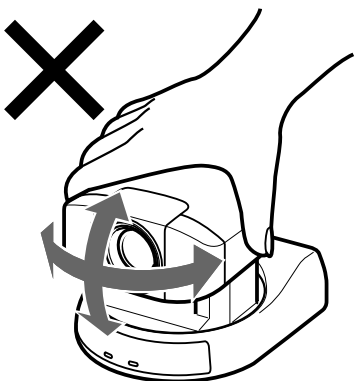
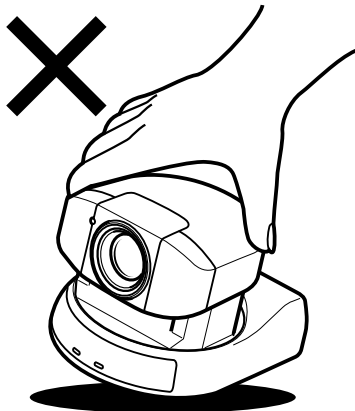

Installation

Be sure to place the main unit on a flat surface.

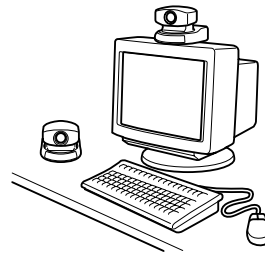

Secure the camera in place with the supplied Velcro tape.

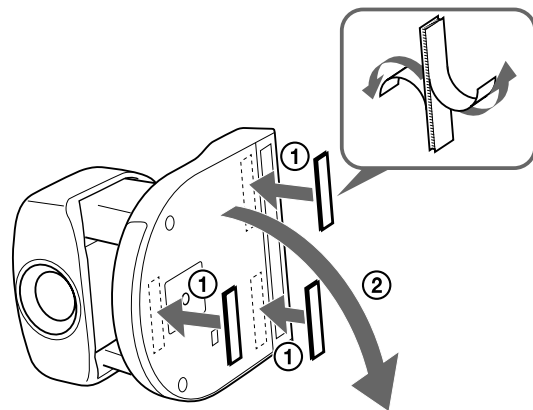

If you operate more than one camera with the remote commander

Notice the CAMERA NO. switch at the rear of the main unit. Set the CAMERA NO. switch to the position that is different from the positions to that of what the other cameras' CAMERA NO. switches are set.

(See page 11.)

CAMERA NO.

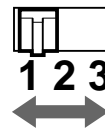

Turning on the Power

- 1 Turn on the POWER switch at the rear of the main unit.

The POWER lamp lights up.

As long as the POWER switch on the main unit is set to ON, you can turn on or off the camera with the POWER switch on the remote commander.

When the power is turned on, the camera will automatically face toward the lower right-hand side and then the front, which is the home position of the camera. (Pan/tilt reset action)

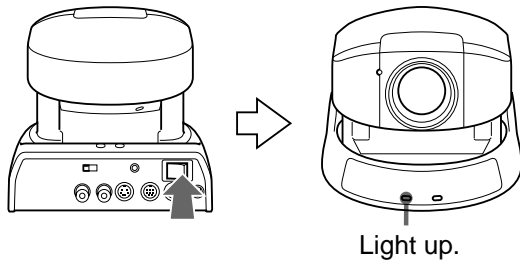

- 2 Turn on the peripheral devices.

Installing batteries

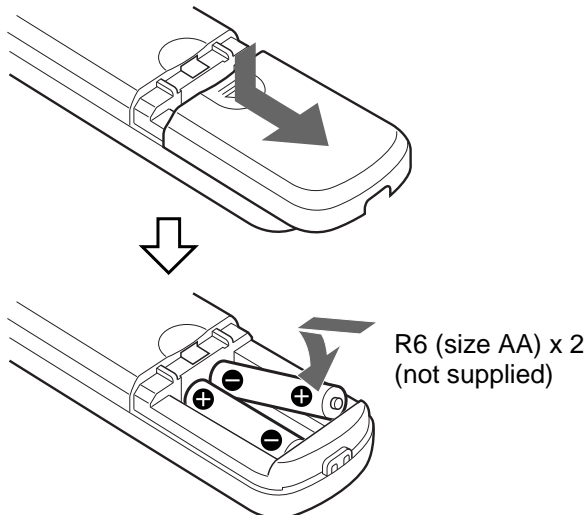

Setting the Clock

Use the buttons on the main unit to set the clock.

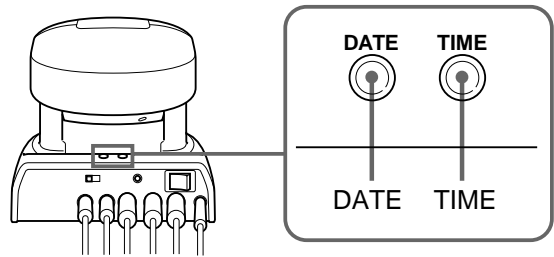

- 1 Press the DATE and TIME buttons at the same time and hold them down for about 2 seconds. Release your hand as the month and date appear and the year starts flashing.

EVI-D30



EVI-D31



- 2 Repeat pressing the DATE button to select the year.

- 3 Press the TIME button to set the year.

EVI-D30



EVI-D31



-
- 4** Repeat the steps 2 and 3 to set the other time elements in the order of month, date, hour, and minute.

The clock starts operating as you press the TIME button to set the minute.

EVI-D30

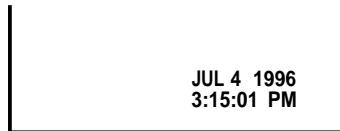

EVI-D31

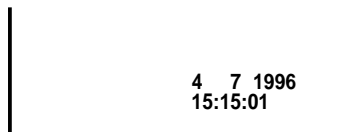

Having the clock displayed

You can select the clock display from either time or date.

To have the time displayed, press the TIME button.

To have the date displayed, press the DATE button.

To turn off the clock display, press the corresponding button again.

Note

When the POWER switch on the main unit is set to OFF, the clock will be as originally was. To retain the memory of the clock setting even if the power is turned off, set the BACKUP switch, at the rear of the camera head, to ON. (See "About backup" on page 25.)

Pan/Tilt Operation

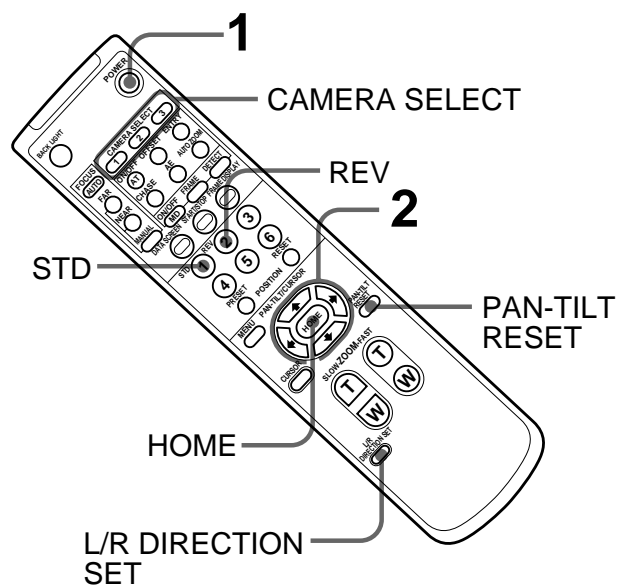

1 Press the POWER button.
The camera will be turned on, performing the pan/tilt reset action automatically.

2 Press the arrow button to perform the pan/tilt operation.
While checking the picture on the screen, press a desired arrow button.
To move the camera inch by inch, press the button for a moment.
To move the camera in a wide range, press and hold down the button.
To move the camera diagonally, press the arrow button (↖ or ↘) while holding down the arrow button (↔ or ↷).

To face the camera back to the front

Press the HOME button.

If you accidentally move the camera with your hand

Press the PAN-TILT RESET button to reset the pan/tilt position.
The deviation from the position that the camera memorizes will be corrected and the operation will be back in order.

If you wish to face the camera toward the opposite direction in which the arrow on a pressed button points

The camera is preset to face toward the right whenever the arrow (↔) button is pressed. You might wish to face the camera toward the opposite direction in which the arrow on a pressed button points, in such a case when you change the direction of the camera while checking the picture on the screen. In this case, press the REV button while holding down the L/R DIRECTION SET button.

To reset that setting, press the STD button while holding down the L/R DIRECTION SET button.

Arrow button	Movement of the camera	Setting
		While holding down L/R DIRECTION SET Press STD 1
		While holding down L/R DIRECTION SET Press REV 2

Note

Repeat the above-mentioned procedure for each remote commander if you are using more than one remote commander. This is because the setting is performed by changing the signal emitted from each remote commander, not by changing the setting of the camera itself.

If the lamp at the side of the lens flashes red

The micro computer inside the camera might not memorize the current pan/tilt position properly. Press the PAN-TILT RESET button to reset the pan/tilt position.

Flashes.

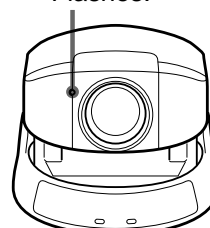

Operating range of the remote commander

Use the remote commander within the range described below, facing it toward the receptor for the remote commander.

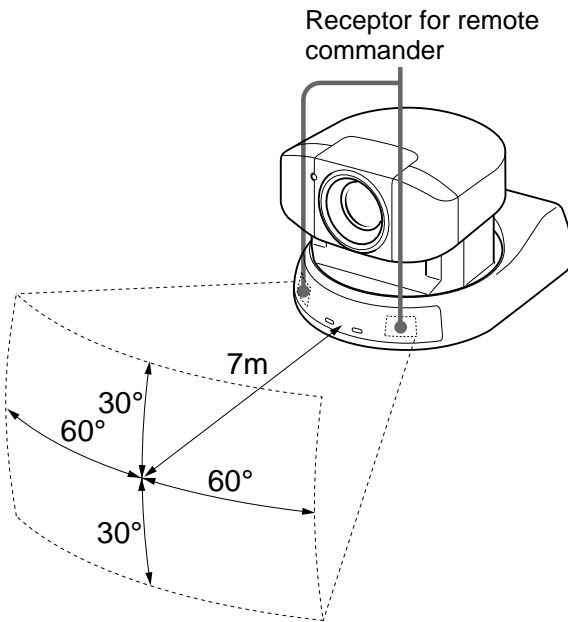

Operating more than one camera with the remote commander

Notice the CAMERA NO. switch at the rear of the camera to be operated.

Press a CAMERA SELECT button whose number is the same as the number to which the CAMERA NO. switch is set.

A pressed CAMERA SELECT button lights up when either of the other button is pressed.

Adjusting the Camera

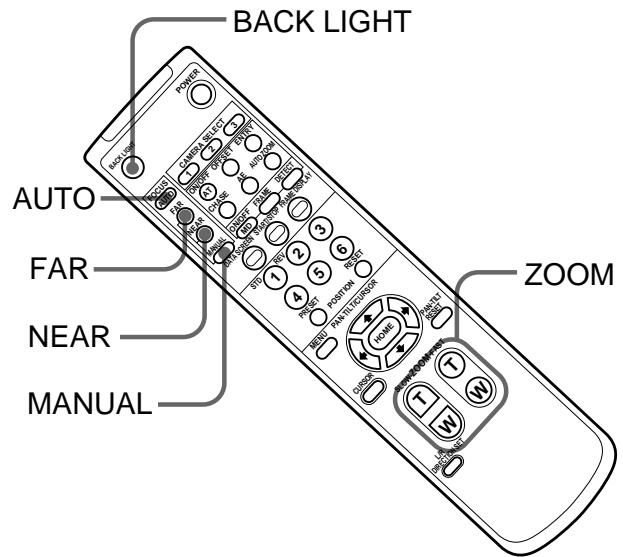

Focusing on a subject

To focus the camera on a subject automatically

Press the AUTO button.

The camera focuses on the subject at the center of the screen automatically.

To focus the camera on a subject manually

After pressing the MANUAL button, press either FAR or NEAR button to have the camera focus on the subject.

Focusing on a far subject

Focusing on a near subject

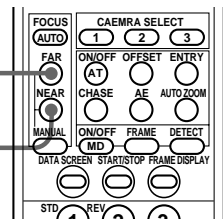

Zooming

Press either of the four ZOOM buttons.

Subject appears farther away. (Wide angle)

Zooms in or out of subject slowly. (SLOW side)

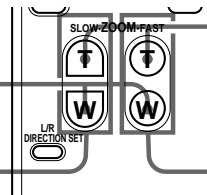

Subject appears closer. (Telephoto)

Zooms in or out of subject fast. (FAST side)

Shooting with back lighting

When you shoot a subject with a light source behind it, the subject becomes dark. In such a case, press the BACK LIGHT button.

To cancel the function, press the BACK LIGHT button again.

Having the Camera Memorize the Setting

—Presetting feature

Up to six combinations of the setting (position, zooming, focusing and back lighting) can be preset.

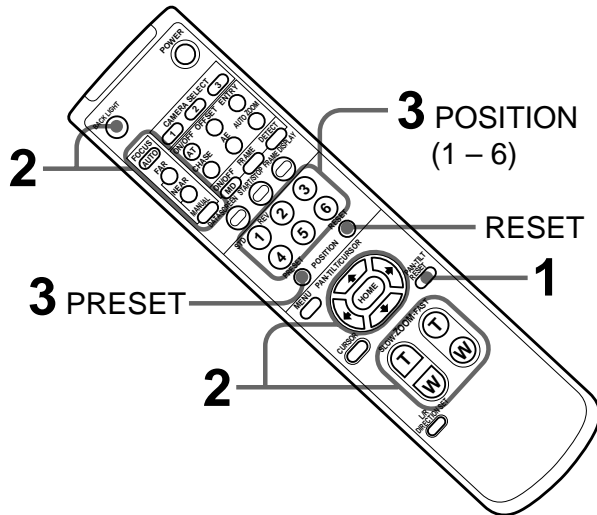

1 Press the PAN-TILT RESET button to reset the pan/tilt position.

2 Adjust the position, zooming, focusing, and back lighting of the camera. (See on page 11.)

3 While holding down the PRESET button, press either of the POSITION buttons 1 – 6.

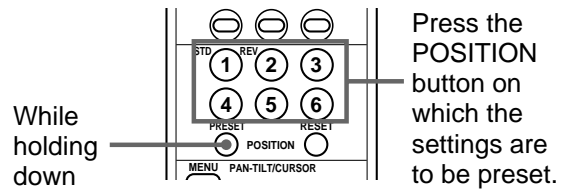

Recalling the memorized setting

Press either of the POSITION buttons 1 – 6.

Canceling the preset memory

While holding down the RESET button, press the POSITION button on which the settings are to be canceled.

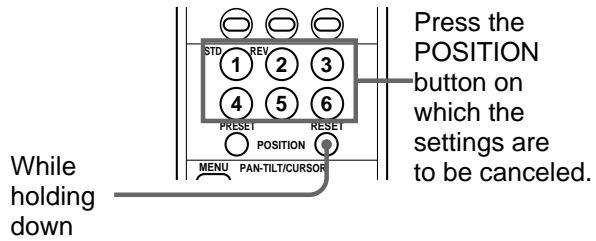

Notes

- Before presetting, be sure to reset the pan/tilt position. Otherwise the correct position will not be memorized.
- The memorized information is retained until the power of the main unit is turned off. To retain the memory even if the power is turned off, set the BACKUP switch, at the rear of the camera head, to ON. (See “About backup” on page 25.)

Tracking a Subject Automatically

—AT (Auto target tracking) function

You can have the camera memorize certain color and brightness so that it automatically tracks a subject having the memorized color and brightness.

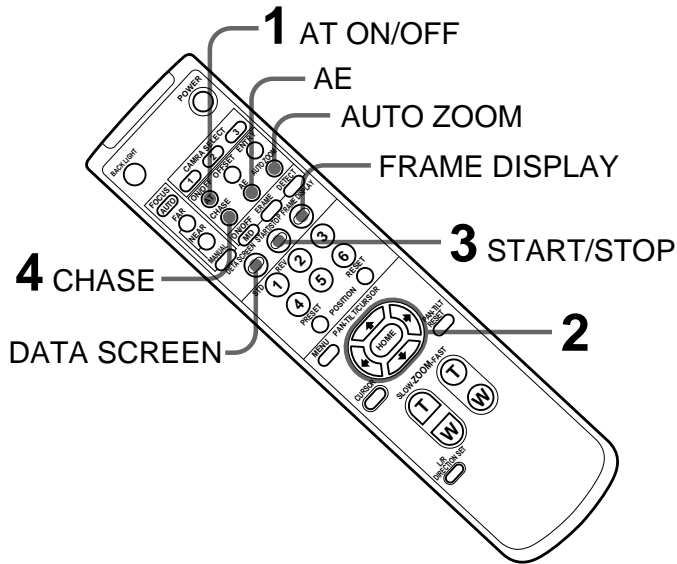

- 1 Press the AT ON/OFF button to enter into the AT setting mode.
The frame and setting value appear.

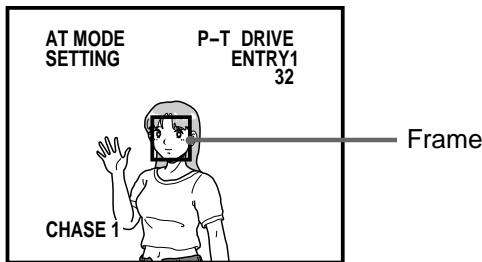

- 2 Press the arrow button to perform the pan/tilt operation so that a subject is placed into the frame.

Be sure to place the subject so that the portion uniform in brightness and color is in the frame.

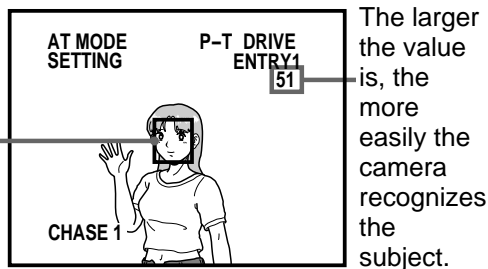

Example of the case when a subject is hardly recognized

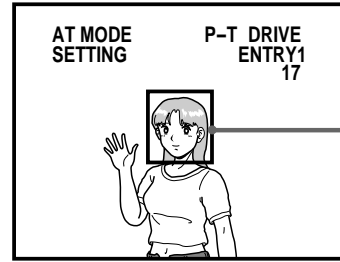

The camera might not recognize a subject if the portion different from the subject in brightness and color, such as the backdrop, is placed together in the frame.

- 3 Press the START/STOP button to activate the AT function.
Try moving the subject to see if the frame tracks it automatically.

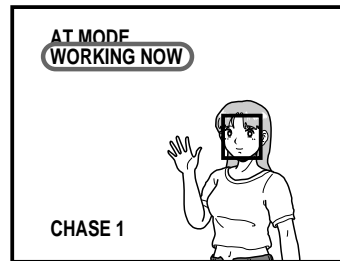

When the frame tracks the subject, proceed with the step 4.

When the frame does not track the subject, repeat the step 3 until the frame starts tracking the subject while adjusting the lighting and the position of the subject so that the color and brightness of the subject is optimized. If the frame still does not track the subject, see “If the subject cannot be recognized or captured” on page 17.

- 4 Repeat pressing the CHASE button to select a desired CHASE mode.

Each time that button is pressed, the mode is cyclically changed as follows:

CHASE 1 → CHASE 2 → CHASE 3
↑



MODE	Tracking method	Intended use
CHASE 1	The pan/tilt action is not performed. (Camera does not move.) The frame tracks a subject only in the range of the screen.	Used to check if the subject is recognized.
CHASE 2	The frame tracks a subject while the pan/tilt action is performed. In this mode, the subject is always placed in the middle of the screen.*	Used to perform normal tracking operation.
CHASE 3	Uses the same tracking method as that of CHASE 1 except that if a subject almost goes out of the screen, the camera performs the pan/tilt action so that the subject is placed in the middle of the screen.*	Used when you wish to limit the camera movement as possible, in such a case when you perform the image transmission.

* The position in which the subject is to be placed can be changed from the middle of the screen. See “Changing the frame position” on page 16.

If the frame is repeatedly extended to the full screen

The camera does not recognize the subject. Press the START/STOP button and go back to the step 2. If doing so does not solve the problem, see “If a subject cannot be recognized or captured” on page 17.

To turn off the setting value and/or frame

If the setting value and/or frame are displayed as you record a picture, those come with the recorded picture.

To turn off the setting value, press the DATA SCREEN button.

To turn off the frame, press the FRAME DISPLAY button.

Note

Once the setting value is turned off, the setting value is not displayed until the next time you press the DATA SCREEN button. However, the setting value is displayed automatically when the unit enters into the AT setting mode for the first time after the power is turned back on.

To keep the brightness of the subject as is (Auto back lighting function)

After the step 2, press the AE button.

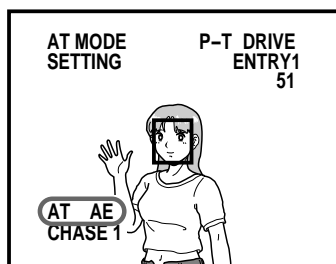

To deactivate the function, press that button again.

Note

Be sure to press the AE button before proceeding with the step 3. This function is not activated after the START/STOP button is pressed.

To keep the size of the memorized subject as is

After the step 2, press the AUTO ZOOM button.

To cancel the function, press that button again.

To cancel the AT function

Press the START/STOP button.

The information of the memorized subject is erased.

To exit from the AT setting mode, press the AT ON/OFF button.

If the lamp at the side of the lens light up

The camera is not capturing the memorized subject correctly.

Press the arrow button to perform the pan/tilt operation so that the subject comes into the screen. Or have the subject memorized onto the camera again.

Lights up.

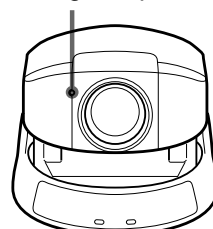

Tracking a Subject Automatically (continued)

Fine-tuning the setting

Changing the frame position

Although the frame normally appears on the middle of the screen, you can change its position to a different place. (In the CHASE 1 mode, the frame tracks a subject within the range of the screen.)

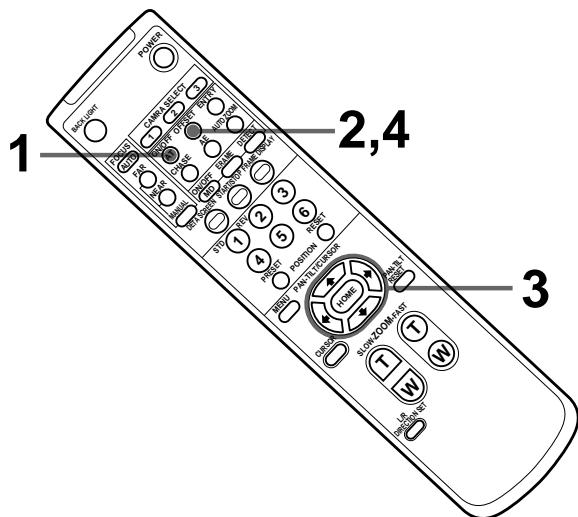

- 3 Press the arrow button to move the frame to a desired position.

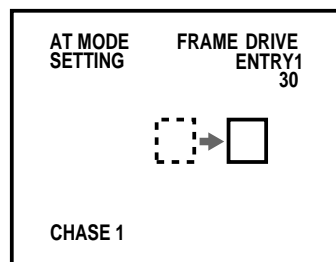

- 4 Press the OFF SET button to fix the frame position.

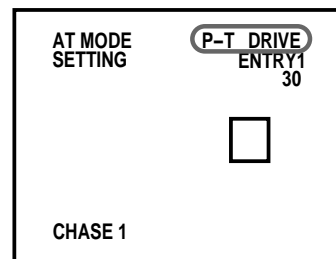

After the setting is completed, go back to the step 2 of “Tracking a subject automatically.”

- 1 Press the AT ON/OFF button to enter into the AT setting mode.

The frame and setting value appear. If the setting value does not appear, press the DATA SCREEN button to have the value displayed.

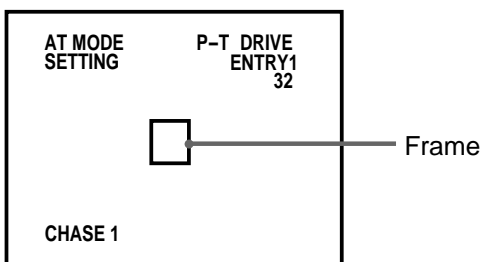

- 2 Press the OFF SET button to enter into the AT frame position setting mode.

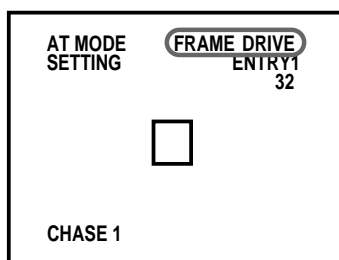

If a subject cannot be recognized or captured

Depending on the characteristic or condition of a subject, the camera might hardly recognize the subject. If the AT function still does not work after the procedures mentioned in pages 14 and 15 are repeated, select an ENTRY mode that is matched to conditions under which the camera is used. Normally, select the ENTRY 1.

Problem	ENTRY mode to be selected
A subject cannot be recognized because its color is too thin.	ENTRY 2
The camera repeats mistakenly recognizing a near object whose color is almost identical to that of a subject. (The frame moves from the subject to an object whose color is almost identical to that of the subject.)	ENTRY 2
The camera repeats mistakenly recognizing the backdrop such as the wall or ceiling. (The frame moves from the subject to the backdrop.)	ENTRY 4
The camera does not capture a subject correctly when the brightness of the subject changes as the position of the subject changes.	ENTRY 3

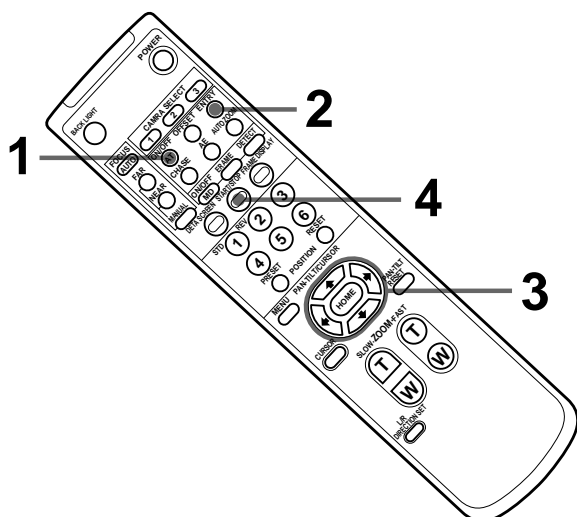

- 1 Press the AT ON/OFF button to enter into the AT setting mode.

The frame and setting value appear. If the setting value does not appear, press the DATA SCREEN button to have the value displayed.

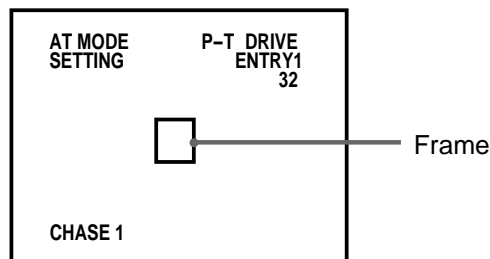

- 2 Repeat pressing the ENTRY button to select a desired ENTRY mode.

Each time that button is pressed, the mode is cyclically changed as follows:

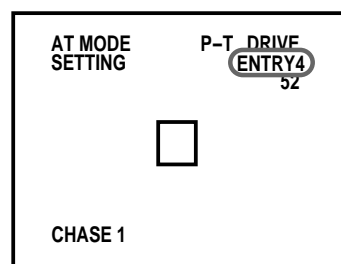
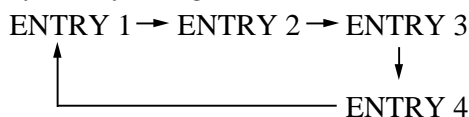

- 3 Have the camera memorize a subject by pressing the arrow button to move the subject into the frame.

The position to which you place the subject varies depending on an ENTRY mode you select.

ENTRY 2: Place the subject so that the portion uniform to a certain extent in color and brightness is in the frame.

ENTRY 3: Place the subject so that it hangs over the frame slightly.

ENTRY 4: Place the subject so that it becomes largest within the frame, its backdrop being out of the frame.

Tracking a Subject Automatically (continued)

- 4 Press the START/STOP button to activate the AT function.

Try moving the subject to see if the frame tracks it automatically.

If you have selected the ENTRY 3, the frame flashes for about 5 seconds after the START/STOP button is pressed. Within that period, repeat changing the angle of the subject so that the camera recognizes the various brightness of the subject.

Notes

- If you use the ENTRY 2 or 4 mode for a subject that can be recognized even in the ENTRY 1 mode, the subject might be hardly recognized. This is because the color and brightness the camera can recognize are limited in the ENTRY 2 and 4 modes.
- Even if you try changing the ENTRY mode, a subject still might not be recognized depending on its characteristics. In such a case, try changing the subject to the one whose color is more bright or the one whose color is different from that of its backdrop, or changing the lighting.
- There might be a case in which the AT function will not be activated in any way depending on the size, color, brightness and so on of a subject.

Detecting the Change Taking Place in the Picture

— MD (Motion Detector) function

If the position of the camera is fixed, you can set the camera to detect a change taking place in a picture. When the camera detects a change taking place in the picture, the frame appears, showing the portion in which the change takes place, and the lamp at the side of the lens lights up red. (At that time, the detection signal is output from the VISCA IN.) You can specify up to two portions in which the change is detected, by using the two frames (FRAME 1 and FRAME 2) that you can change in position and size as desired.

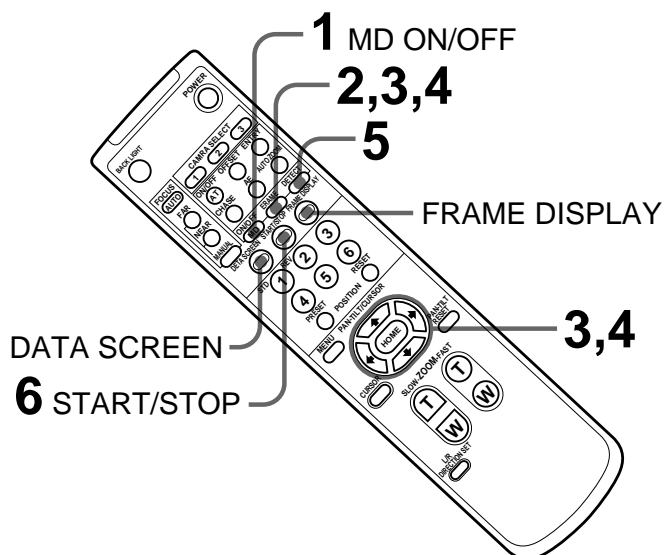

- 1 Press the MD ON/OFF button to enter into the MD setting mode.

The frame and setting value appear.

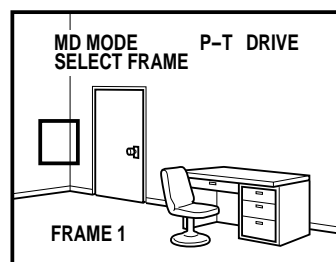

- 2** Press the FRAME button to enter into the detection frame setting mode.

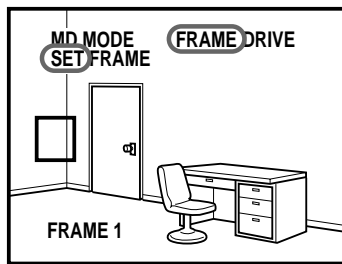

- 3** Decide the position and size of the FRAME 1.

- ① Press the arrow button to set the position of the FRAME 1. Then press the FRAME button.

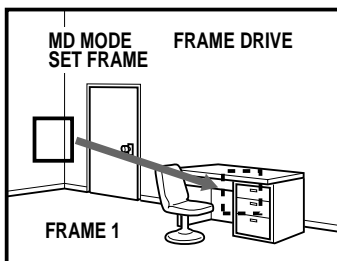

- ② Press the arrow button to set the size of the FRAME 1. Then press the FRAME button.

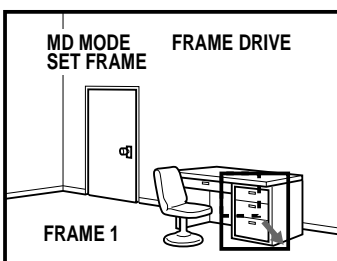

That completes the settings of the FRAME 1's position and size, and enter into the setting mode of the FRAME 2.

If you choose not to set the FRAME 2, proceed with the step 5.

- 4** Repeat the procedure of the step 3 to set the FRAME 2's position and size.

- 5** Repeat pressing the DETECT button to select a frame to be used.

Each time that button is pressed, the frame to be used is cyclically changed as follows:

FRAME 1 → FRAME 2 → F1 & F2*

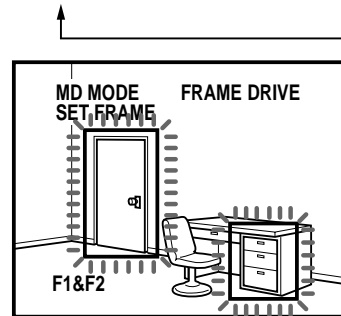

* If a change is detected even in either of FRAME 1 or FRAME 2, the lamp at the side of the lens lights up red.

- 6** Press the START/STOP button to activate the MD function.

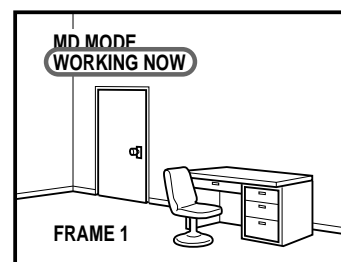

To turn off the setting value and/or frame

If the setting value and/or frame are displayed as you record a picture, those come with the recorded picture.

To turn off the setting value, press the DATA SCREEN button.

To turn off the frame, press the FRAME DISPLAY button.

To cancel the MD function

Press the START/STOP button.

To exit from the MD mode, press the MD ON/OFF button.

Note

Once the frame is set, it remains memorized until the power is turned off.

To retain the memory of the frame setting even if the power is turned off, set the BACKUP switch, at the rear of the camera head, to ON. (See "About backup" on page 25.)

Detecting the Change Taking Place in the Picture (continued)

Fine-tuning the settings

The MD function works in the following manner: the camera memorizes a picture of a certain moment as the “reference picture,” and compares the current picture with the reference picture to detect whether or not a change takes place.

Although the camera is factory-set to refresh a reference picture after a certain period of time, you can change the timing when a reference picture is refreshed or can set the camera not to refresh the reference picture, according to conditions under which the camera is used.

In addition, you can adjust the parameter that sets the camera to detect a certain kind of change such as color and brightness.

Condition under which the camera is used	Reference picture refreshing mode to be selected	When to refresh picture
--	--	-------------------------

Sunlight comes in, and the light source changes over time.	MODE 1	The reference picture is automatically refreshed after a certain period of time (Factory-setting : approx. 0.1 second)
--	--------	--

<ul style="list-style-type: none"> Sunlight comes in, and the quantity of light changes over time. You wish to have the camera detect only a sudden change. 	MODE 2	The reference picture is automatically refreshed after a certain period of time unless a change has taken place in the picture. When a change is being detected, the reference picture is not refreshed.
---	--------	--

<ul style="list-style-type: none"> Sunlight does not come in, and the brightness of the light source does not change. You wish to have the camera detect even a slight change. 	MODE 3	The reference picture is always as originally was.
--	--------	--

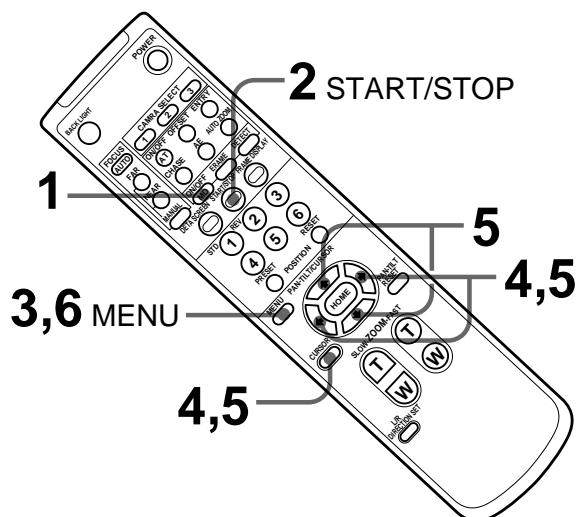

- 1 Press the MD ON/OFF button to enter into the MD setting mode.

The frame and setting value appear. If the setting value does not appear, press the DATA SCREEN button to have the setting value displayed.

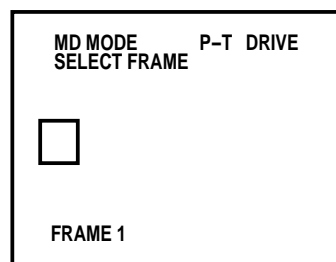



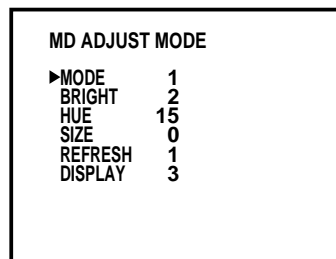

- 2 Press the START/STOP button to start the detection operation.

- 3 Press the MENU button to enter into the MD ADJUST MODE.



- 4 While holding down the CURSOR button, press the arrow button (◀ or ▶) to select a desired reference picture refreshing mode (1 – 3).

5 Adjust each parameter.

- ① While holding down the CURSOR button, press the arrow button ( or ) to select a desired parameter.
- ② While holding down the CURSOR button, press the arrow button ( or ) to select a desired value.

Adjust the value of each parameter as specified below, in the order from top to bottom.

	MODE 1	MODE 2	MODE 3
BRIGHT	2	2	2
HUE	15	15	15
SIZE	0	0	0
REFRESH	1	8	—*
DISPLAY	3	0	0

*When the MODE 3 is selected, you cannot change the value of REFRESH since the reference picture is not refreshed in that mode.

6 Press the MENU button to complete the setting.

If the detection operation is not performed properly, see “Adjusting the value of each parameter.”

Adjusting the value of each parameter

At the step 5 of “Fine-tuning the setting,” you can adjust the value of each parameter as desired. Refer to the following information provided below and adjust the value of each parameter while checking how the detection operation is performed.

Parameter	Content/Tips in setting	Adjustable range
BRIGHT* ¹ (Sensitivity to brightness)	Sets the sensitivity to a change in brightness. The lesser the value, the more sensitively the camera detects the change. Adjust this value within the range in which an error does not occur.	0 to 14, 15 (Parameter disabled)
HUE* ² (Sensitivity to hue)	Sets the sensitivity to a change in color. The lesser the value, the more subtle change in color the camera detects. Adjust this value when the camera hardly detects the change with only the BRIGHT adjusted, in such a case when the brightness of a subject to be captured is almost identical to that of its backdrop.	0 (5°) to 14 (75°), 15 (Parameter disabled)
SIZE* ³ (Sensitivity to size)	Sets the sensitivity to the size of the frame area being taken up by a changed portion. Adjust this value in such a case when you wish to have the camera detect only a greater change.	0 (approx. 0.3%) to 15 (approx. 20%)
REFRESH* ⁴ (Reference picture refreshing timing)	Sets the period of time for which the reference picture is retained.	0 (0.07 sec.) to 15 (60 min.)
DISPLAY (Signal output duration)	Sets the period of time for which the detection signal continues to be generated once a change has been detected.	0 (0.07 sec.) to 14 (30 min.), 15 (continuous)

*1 After the value of the BRIGHT has been changed, the value of the HUE is automatically set to 15 and the value of the SIZE to 0.

*2 After the value of the HUE has been changed, the value of the BRIGHT is automatically set to 15 and the value of the SIZE to 0.

*3 Be sure to adjust the value of the SIZE after adjusting the values of the BRIGHT and HUE.

- The camera might not be able to detect a change if both the size of the frame and the value of the SIZE are too small.

*4 Can be adjusted only when the camera is in the MODE 1 or MODE 2.

Locations of Controls

For details, see the pages indicated in ●.

Main unit

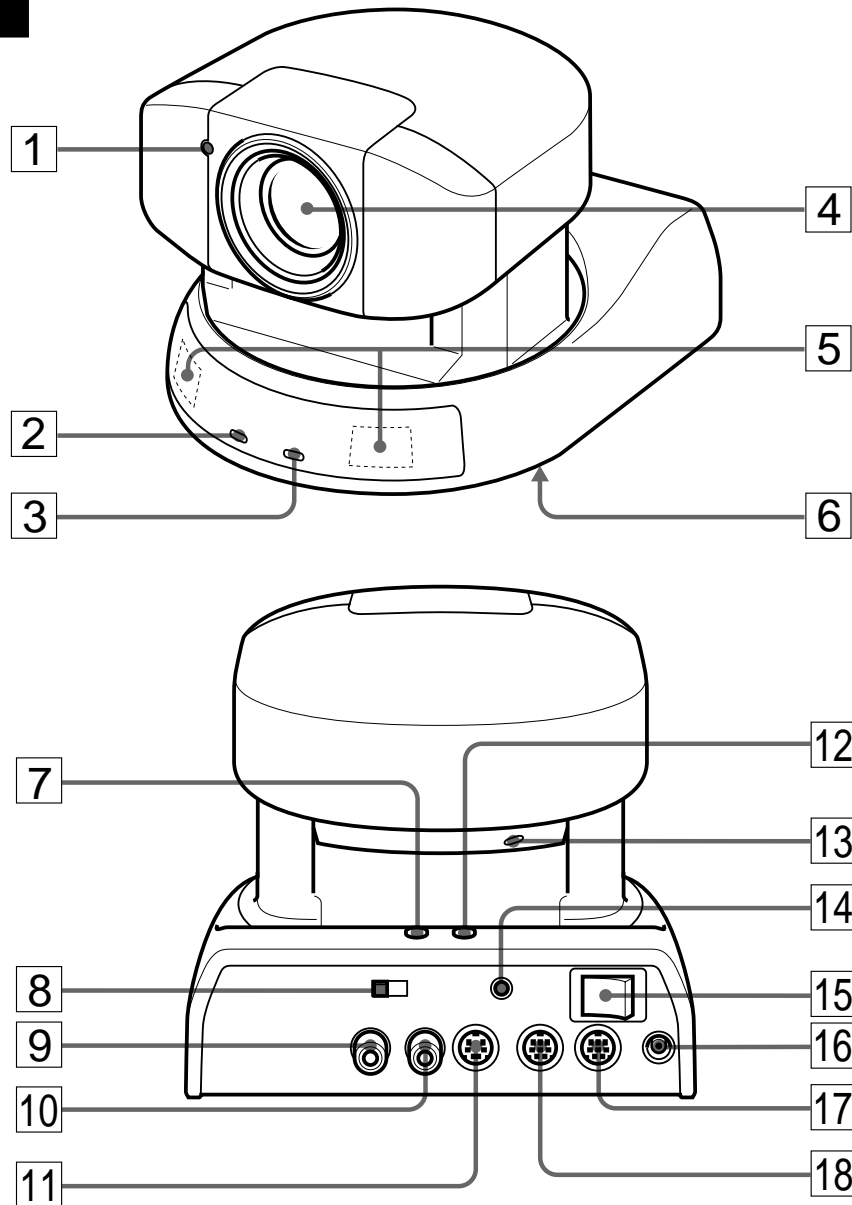

- | | | | | | | |
|---|-------------------------------|----|----|----|------------------|----|
| 1 | Caution lamp | 10 | 15 | 9 | VIDEO OUT jack | 6 |
| 2 | POWER lamp | 8 | | 10 | AUDIO OUT jack | 6 |
| 3 | RECEIVE lamp | | | 11 | S VIDEO OUT jack | 6 |
| 4 | Lens | | | 12 | DATE button | 8 |
| 5 | Receptor for remote commander | 11 | | 13 | BACK UP switch | 25 |
| 6 | IR OUT switch | | | 14 | MIC jack | 6 |
| | | | | 15 | POWER switch | 8 |
| | | | | 16 | DC IN 13.5V jack | 6 |
| 7 | TIME button | 8 | | 17 | VISCA OUT jack | 6 |
| 8 | CAMERA NO. switch | 7 | 11 | 18 | VISCA IN jack | 6 |

Use when equipment such as a VTR and personal computer, and/or another Color Video Camera are connected with a VISCA cable.

Remote commander

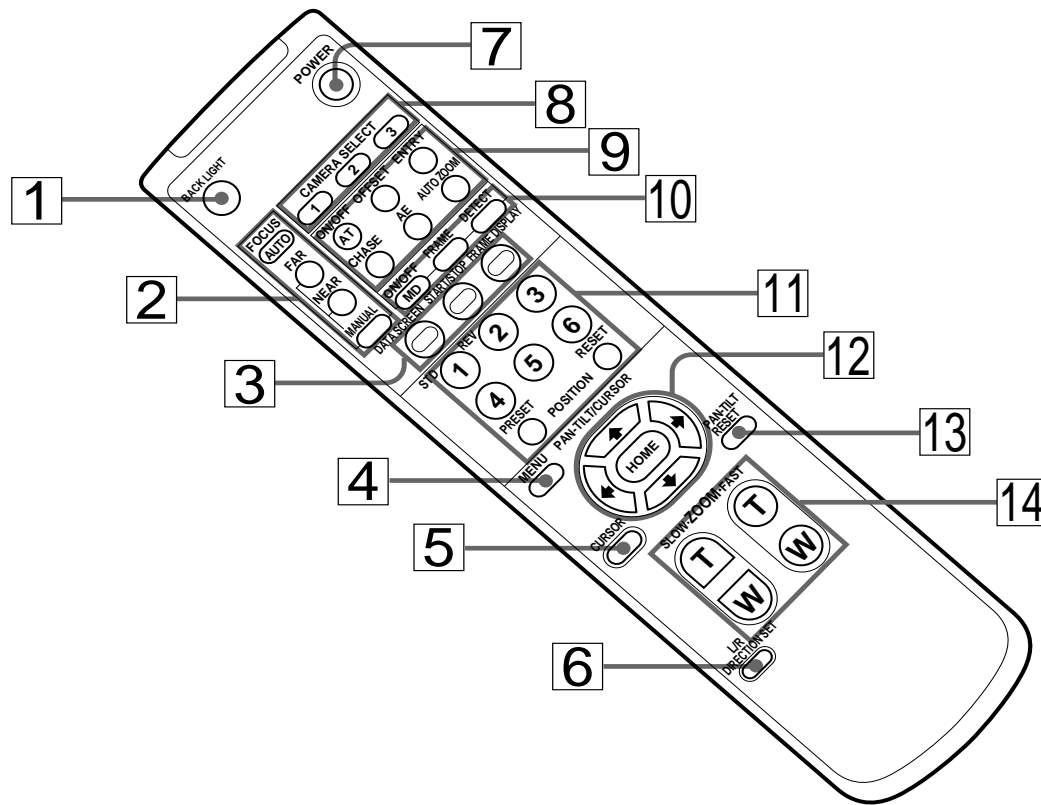

- | | |
|---|--|
| 1 BACK LIGHT button 11 | 10 MD mode buttons |
| 2 FOCUS buttons 11 | MD ON/OFF button 18 |
| AUTO button | FRAME button 19 |
| FAR button | DETECT button 19 |
| NEAR button | 11 POSITION buttons 12 |
| MANUAL button | Numeric buttons (Button 1 also works as the |
| 3 DATA SCREEN button 15 | STD button./Button 2 also works as the REV |
| START/STOP button 14 19 | button.) 10 |
| FRAME DISPLAY button 15 | PRESET button |
| 4 MENU button 20 | RESET button |
| 5 CURSOR button 21 | 12 PAN-TILT/CURSOR button 10 14 16 19 |
| 6 L/R DIRECTION SET button 10 | Arrow buttons |
| 7 POWER switch 10 | HOME button |
| 8 CAMERA SELECT buttons 11 | 13 PAN-TILT RESET button 10 |
| 9 AT mode buttons | 14 ZOOM buttons 11 |
| AT ON/OFF button 14 | SLOW T button |
| OFF SET button 16 | SLOW W button |
| ENTRY button 17 | FAST T button |
| CHASE button 14 | FAST W button |
| AE button 15 | |
| AUTO ZOOM button 15 | |

Locations of Controls (continued)

Screen indications

AT setting mode ⑭ – ⑰

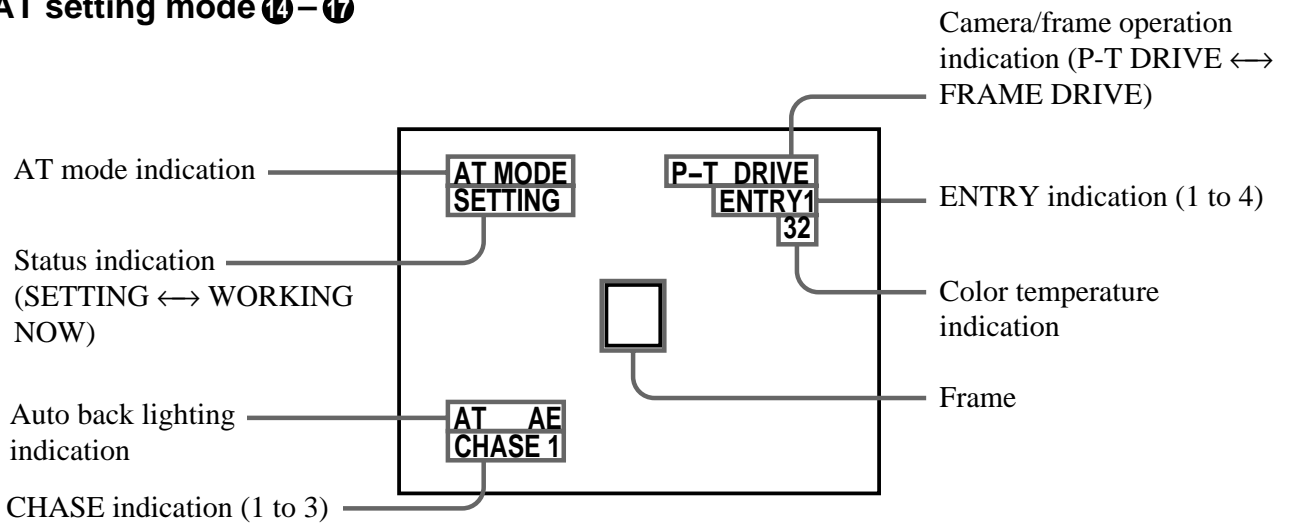

MD setting mode ⑱ ⑲

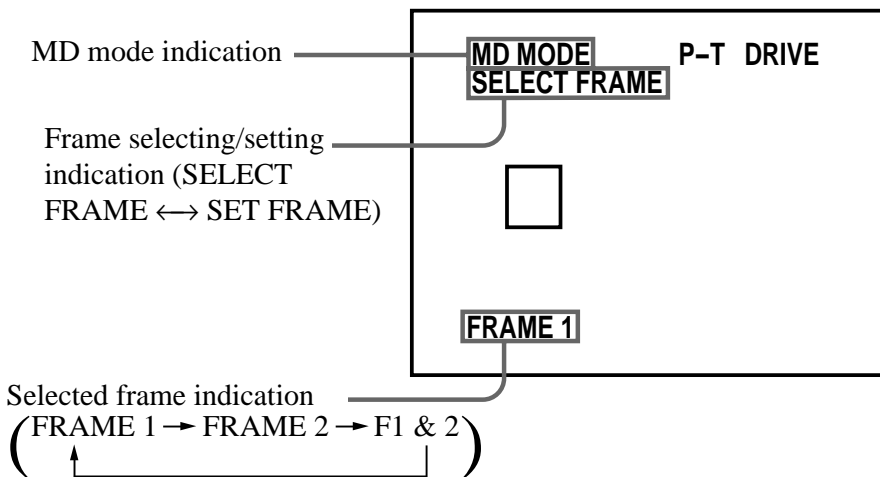

MD adjusting mode ⑳

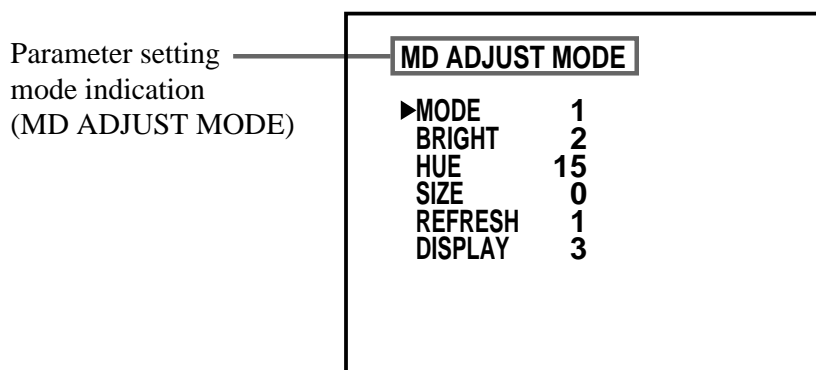

Precautions

- The name plate indication operating voltage, power consumption, etc. is located on the bottom exterior.
- After operating the unit with an AC power adaptor, disconnect the AC power adaptor from the wall outlet if the set is not to be used for an extended period of time. The POWER switch on the rear of the main unit, does not turn the AC adaptor off.

Brightness of a subject

Color Video Camera might not work with its best performance in a place where brightness exceeds the illumination range (such as a place exposed to direct sunlight).

Avoid specialized application

Avoid using Color Video Camera for monitoring application where it would be forced to focus on a stationary object for a long period of time. Also avoid focusing the camera on an extremely bright object such as sunlight or a fluorescent lamp. Otherwise the color filter might be damaged.

Precaution on copyright

Television programs, pictures, magazines, and other materials may be copyrighted. Unauthorized recording or storing of such materials violates the provision of the copyright laws.

When you discard Color Video Camera

For environmental reasons, take out a lithium battery from the camera and discard it accordingly.

- 1 Remove the screw at the rear of the camera head using a Phillips type screw driver and detach the cabinet.

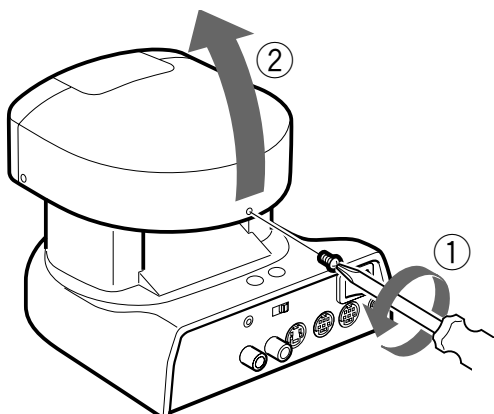

- 2 Remove the stopper and connector.

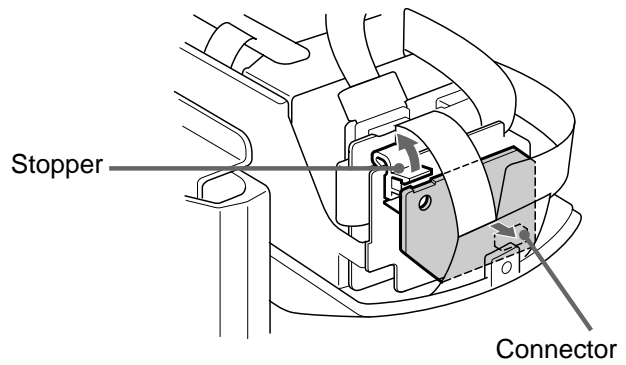

- 3 Remove the lithium battery together with the board.

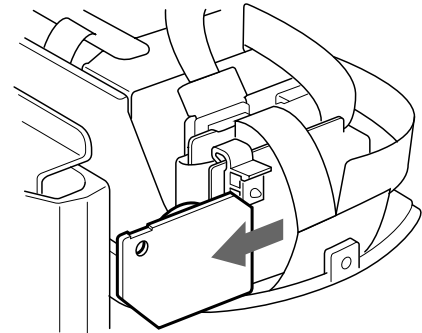

Dispose of the lithium battery according to the local law.

About backup

The memories of the settings such as the clock, camera's position and MD function are erased when the POWER switch on the main unit is set to OFF. To retain those memories, set the BACK UP switch, at the rear of the camera head, to ON.

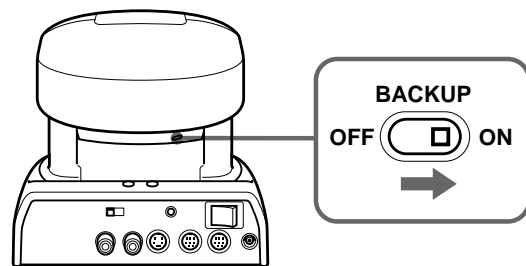

Notes

- In this unit, the built-in lithium battery acts as the power source for retaining the memories and is kept charged as long as the unit is used. If the unit is used for shorter period of time with the BACKUP switch set to ON, however, the battery is gradually discharged. Besides, if you do not use the unit at all for almost 12 weeks, the battery is completely discharged. To retain the memories of the settings, you should recharge the battery.
- To recharge the battery, plug in the unit to an AC outlet with the AC power adaptor and leave it for approximately 48 hours with the POWER switch on the main unit set to ON.

Maintenance

Clean dirt and soil with a soft cloth or tissue paper.

Cleaning the main unit

- When the body is too dirty, clean it with a soft cloth that is soaked with a diluted neutral detergent and tightly wrung. Then finish with a dry cloth.
- Do not use any type of solvents, which may damage the finish.
- When you use a chemical cloth, follow its instructions.
- Do not sprinkle volatile matter such as pesticide over Color Video Camera nor allow rubber or vinyl to come in contact with Color Video Camera for a long period of time. Doing so may damage the finish.

Replacing the batteries of the remote commander

If the remote commander does not operate from a longer distance, the batteries may be worn out. Replace the batteries with new ones (AA × 2).

Troubleshooting

Symptom	Remedy
The picture does not appear on the screen of the AV personal computer.	<ul style="list-style-type: none"> • Make sure the connections are made correctly. • Have Color Video Camera tested by connecting it to other equipment such as a TV or video deck.
The picture and sound qualities are not as good as those of TV when you connect Color Video Camera to AV personal computer.	Depending on a computer or video capture board, you may not be able to obtain the same picture and sound qualities as those of TV. Consult your computer manufacturer or dealer for details.

Symptom	Remedy
The unit cannot be operated when a button on the remote commander is pressed.	<ul style="list-style-type: none"> • Set the POWER switch, at the rear of the main unit, to ON. • Press a CAMERA SELECT button whose number is the same as the number to which the CAMERA No. switch of the camera is set. • Replace the batteries of the remote commander with new ones. • Plug in the AC power adaptor to an AC outlet.
The unit cannot be operated when either of the POSITION buttons (1 to 6) is pressed.	<p>Check which mode the camera is in.</p> <p>If the camera is in the AT mode, press the AT ON/OFF button to exit from that mode.</p> <p>If the camera is in the MD mode, press the MD ON/OFF button to exit from that mode.</p>
The unit cannot be operated when an arrow button, the HOME button, or the PAN-TILT RESET button is pressed.	Press the MD ON/OFF button to exit from the MD mode.
The unit cannot be operated when an arrow button is pressed.	<p>Check which mode the camera is in.</p> <p>If the camera is in the AT frame position setting mode, press the AT ON/OFF button to exit from that mode.</p> <p>If the camera is in the detection frame setting mode, press the MD ON/OFF button to exit from that mode.</p>
The unit cannot be operated by any means.	<p>Turn off and then back on after a while the POWER switch at the rear of the main unit.</p> <p>If you still cannot operate the unit, set the BACK UP switch to OFF and turn off and then back on the POWER switch. (Note that the memories of each setting will be erased when the BACK UP switch is set to OFF.)</p>

Specifications

System

Video signal	EVI-D30: NTSC Color, EIAJ standards EVI-D31: PAL Color, CCIR standards
Picture element	1/3 inch color CCD (Total picture element number: EVI-D30: Approx. 410,000 EVI-D31: Approx. 470,000) (Effective picture element number: EVI-D30: Approx. 380,000 EVI-D31: Approx. 440,000)
Lens	Electromotion twelve fold zoom lens f=5.4 to 64.8mm, F1.8 to F2.7 Horizontal angle: 4.4° to 48.8°
Point-blank range	WIDE end : 10mm TELE end : 800mm
Minimum illumination	7 lux (F1.8)/with 50IRE
Illumination range	7 to 100,000 lux
Shutter speed	EVI-D30: 1/60 to 1/10,000 (VISCA control) EVI-D31: 1/50 to 1/10,000 (VISCA control)
Gain selector	Automatic/manual
Horizontal resolution	NTSC : 460 TV PAL : 450 TV
Video S/N	48 dB
Pan/tilt action	Horizontal: 100°, Vertical: 25°

Input/output terminals

Video output	RCA pin jack (1), 1Vpp, 75 ohm unbalanced Synchronization: negative
S video output	4 pin mini DIN (1)
Audio output	RCA pin jack, monaural (1) Rated output: 327 mV Output impedance: less than 2.2 kilohms
Input/output control terminals	RS232C (input: 1, output: 1), 8 pin mini DIN, 9600bps Data: 8 bit Stop bit: 1
Microphone input terminal	Mini jack (monaural) (1) (ø 3.5) Rated input 0.775 mV DC 3V for low impedance microphone Input impedance: more than 10 kilohms
Power terminal	EIAJ type4

General

Input voltage	DC 12 to 14 V
Power consumption	11 W
Operating temperature	0° to 40° (32° to 104°F)
Storage temperature	- 20° to 60° (- 4° to 140°F)
Dimensions	Video camera: Approx 142 × 109 × 164 mm (5 5/8 × 4 3/8 × 6 1/2 in.) (w/h/d) Remote commander: Approx. 56 × 26 × 210 mm (2 1/4 × 1 1/16 × 8 3/8 in.) (w/h/d)
Mass	Video camera: Approx. 1,200 g (42.3 oz.) Remote commander: Approx. 109 g (3.8 oz.)

Supplied accessories

AC power adaptor (1)
Audio/video cable (1)
Remote commander (1)
Velcro tape (3 sets)